

794761-1 ✓ ACTIVE

MATE-N-LOK | Universal MATE-N-LOK

TE Internal #: 794761-1

Rectangular Power Connectors, Housing, Receptacle, Wire-to-Panel / Wire-to-Wire, 9 Position, 6.35 mm [.25 in] Centerline, Universal MATE-N-LOK

[View on TE.com >](#)



Connectors > Power Connectors > Rectangular Power > Rectangular Power Connectors

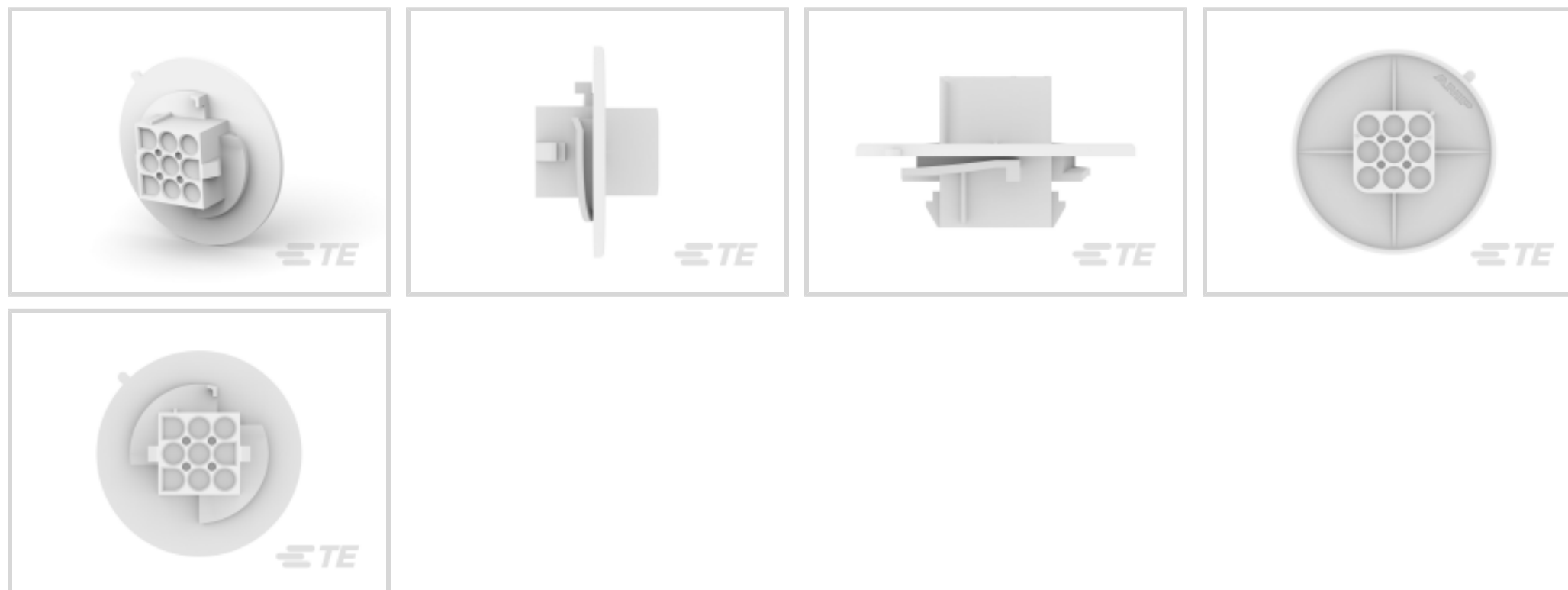

Rectangular Power Connector Type: **Housing**

Connector & Housing Type: **Receptacle**

Connector System: **Wire-to-Panel, Wire-to-Wire**

Number of Positions: **9**

Centerline (Pitch): **6.35 mm [.25 in]**

Features

Product Type Features

Rectangular Power Connector Type	Housing
Connector & Housing Type	Receptacle
Connector System	Wire-to-Panel, Wire-to-Wire
Sealable	No
Connector & Contact Terminates To	Wire & Cable

Configuration Features

Number of Positions	9
Number of Power Positions	0
Number of Signal Positions	0
Number of Rows	3

Electrical Characteristics

Operating Voltage	600 VAC
-------------------	---------

Contact Features

Multiple Contact Types	Without
------------------------	---------



Contact Layout	Matrix
----------------	--------

Contact Retention Within Housing	Without
----------------------------------	---------

Contact Type	Pin
--------------	-----

Termination Features

Termination Method to Wire & Cable	Crimp
------------------------------------	-------

Mechanical Attachment

Panel Mount Feature	With
---------------------	------

Panel Mount Feature Type	Twist & Lock Flange
--------------------------	---------------------

Connector Mounting Type	Panel Mount
-------------------------	-------------

Housing Features

Centerline (Pitch)	6.35 mm [.25 in]
--------------------	------------------

Housing Color	Natural
---------------	---------

Housing Material	Nylon
------------------	-------

Dimensions

Row-to-Row Spacing	6.35 mm [.25 in]
--------------------	------------------

Panel Thickness	.76 – 2.29 mm [.03 – .09 in]
-----------------	------------------------------

Usage Conditions

Operating Temperature Range	-55 – 105 °C [-67 – 221 °F]
-----------------------------	-----------------------------

Operation/Application

Assembly Integration Feature	Without
------------------------------	---------

Circuit Application	Power & Signal
---------------------	----------------

Industry Standards

UL Flammability Rating	UL 94V-0
------------------------	----------

Glow Wire Rating	Standard Part - Not Glow Wire
------------------	-------------------------------

Agency/Standard Number	E28476
------------------------	--------

Agency/Standard	UL
-----------------	----

Packaging Features

Packaging Method	Package
------------------	---------

Packaging Quantity	1
--------------------	---

Other

For Use With	Universal MATE-N-LOK Plug
--------------	---------------------------

Product Compliance

[For compliance documentation, visit the product page on TE.com>](#)

EU RoHS Directive 2011/65/EU	Compliant
EU ELV Directive 2000/53/EC	Compliant
China RoHS 2 Directive MIIT Order No 32, 2016	No Restricted Materials Above Threshold
EU REACH Regulation (EC) No. 1907/2006	Current ECHA Candidate List: JUNE 2022 (224) Candidate List Declared Against: JUNE 2022 (224) Does not contain REACH SVHC
Halogen Content	Low Halogen - Br, Cl, F, I < 900 ppm per homogenous material. Also BFR/CFR/PVC Free
Solder Process Capability	Not applicable for solder process capability











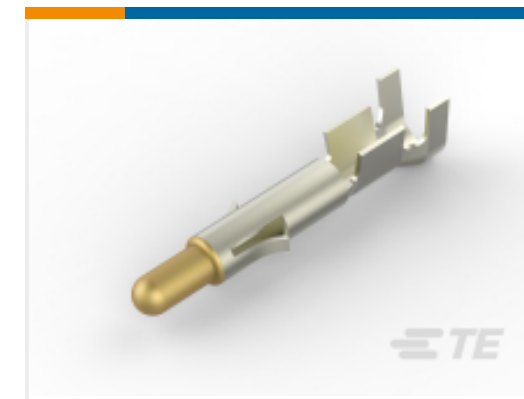

Product Compliance Disclaimer

This information is provided based on reasonable inquiry of our suppliers and represents our current actual knowledge based on the information they provided. This information is subject to change. The part numbers that TE has identified as EU RoHS compliant have a maximum concentration of 0.1% by weight in homogenous materials for lead, hexavalent chromium, mercury, PBB, PBDE, DBP, BBP, DEHP, DIBP, and 0.01% for cadmium, or qualify for an exemption to these limits as defined in the Annexes of Directive 2011/65/EU (RoHS2). Finished electrical and electronic equipment products will be CE marked as required by Directive 2011/65/EU. Components may not be CE marked. Additionally, the part numbers that TE has identified as EU ELV compliant have a maximum concentration of 0.1% by weight in homogenous materials for lead, hexavalent chromium, and mercury, and 0.01% for cadmium, or qualify for an exemption to these limits as defined in the Annexes of Directive 2000/53/EC (ELV). Regarding the REACH Regulation, the information TE provides on SVHC in articles for this part number is based on the latest European Chemicals Agency (ECHA) 'Guidance on requirements for substances in articles' posted at this URL: <https://echa.europa.eu/guidance-documents/guidance-on-reach>

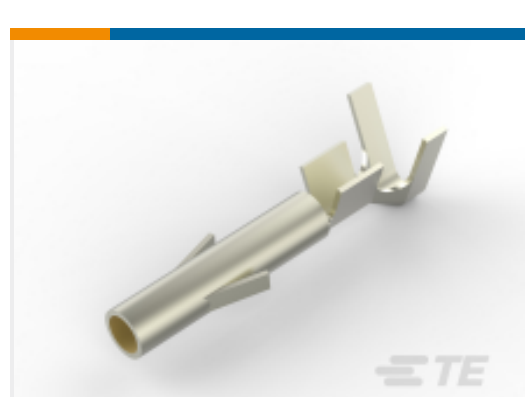

Compatible Parts

 <p>TE Part # 640309-6 UMNL PIN 12-10 AU/PHBZ</p>	 <p>TE Part # 350551-6 UMNL SOK 20-14 AU/PHBZ L/P</p>	 <p>TE Part # 350690-2 UMNL PIN 24-18 AUBR L/P</p>	 <p>TE Part # 926902-3 UNIV-MNL SPLIT ST</p>
--	---	---	---

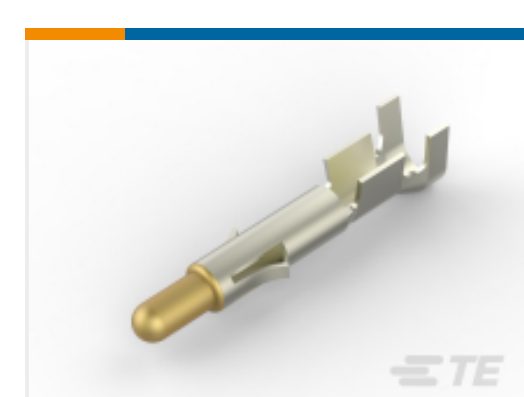

 <p>TE Part # 350550-7 UMNL SOK 20-14 AU/BR L/P</p>	 <p>TE Part # 350690-3 UMNL PIN 24-18 PTPPHBZ L/P</p>	 <p>TE Part # 350689-7 UMNL SOK 24-18 AUBR L/P</p>	 <p>TE Part # 350547-7 UMNL PIN 20-14 AUBR L/P</p>
 <p>TE Part # 350689-2 UMNL SOK 24-18 AUBR L/P</p>	 <p>TE Part # 640310-3 UMNL SOK 12-10 PTPPHBZ</p>	 <p>TE Part # 350689-3 UMNL SOK 24-18 PTPPHBZ L/P</p>	 <p>TE Part # 350690-7 UMNL PIN 24-18 AUBR L/P</p>
 <p>TE Part # 350689-1 UMNL SOK 24-18 PTPBR L/P</p>	 <p>TE Part # 926893-3 UNIV.M-N-L.SOCKET</p>	 <p>TE Part # 350550-6 UMNL SOK 20-14 AU/PHBZ L/P</p>	 <p>TE Part # 350547-3 UMNL PIN 20-14 PTPPHBZ L/P</p>
 <p>TE Part # 350551-7 UMNL SOK 20-14 AU/BR L/P</p>	 <p>TE Part # 350550-2 UMNL SOK 20-14 AU/BR L/P</p>	 <p>TE Part # 770672-1 UMNL PIN 30-26 PTPBR L/P</p>	 <p>TE Part # 350547-6 UMNL PIN 20-14 AU/PHBZ L/P</p>

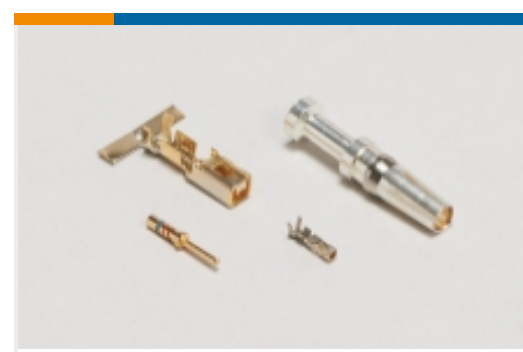
Also in the Series | **Universal MATE-N-LOK**

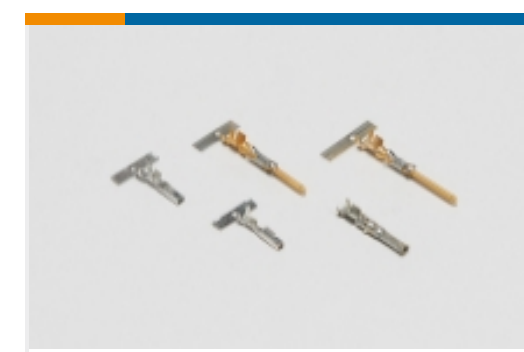
 <p>Circular Power Connectors(2)</p>	 <p>Connector Contacts(11)</p>	 <p>Insertion & Extraction Tools(4)</p>	 <p>Power Contacts(207)</p>
---	--	--	--

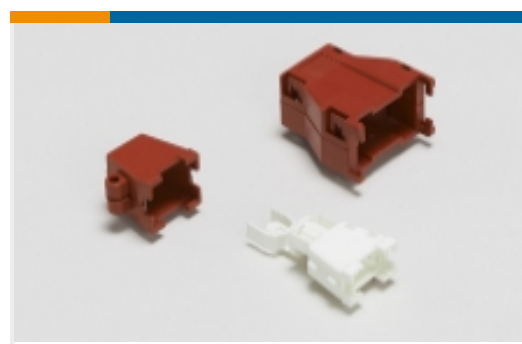

Rectangular Boots & Strain Relief(35)

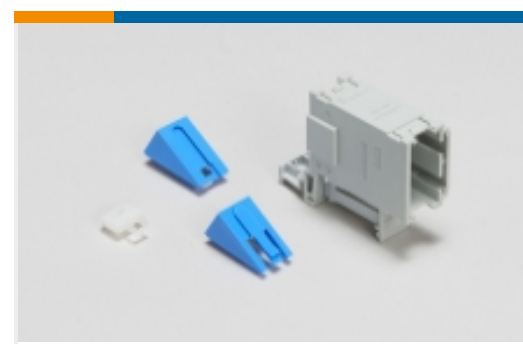

Rectangular Connector Adapters(7)



Rectangular Connector Hardware(1)



Rectangular Connector Housings(2)



Rectangular Connector Keying Plugs(3)



Rectangular Connector Locking(4)



Rectangular Connector Seals(26)



Rectangular Power Connectors(728)

Documents

Product Drawings

[09P UMNL CAP HSG WHITE,P/MT,V0](#)

English

CAD Files

[3D PDF](#)

3D

Customer View Model

[ENG_CVM_CVM_794761-1_M.2d_dxf.zip](#)

English

Customer View Model

[ENG_CVM_CVM_794761-1_M.3d_igs.zip](#)

English

Customer View Model

[ENG_CVM_CVM_794761-1_M.3d_stp.zip](#)

English

By downloading the CAD file I accept and agree to the [Terms and Conditions](#) of use.

Datasheets & Catalog Pages

[SOFT_SHELL_PIN_SOCKET_CONNECTORS_STANDARD_DENSITY](#)

English

Product Specifications

[Application Specification](#)

English

Product Environmental Compliance

[TE Material Declaration](#)



English

[MD_794761-1_06112018100_dmtec](#)

English

[MD_794761-1_06112018100_dmtec](#)

English

Instruction Sheets

[Instruction Sheet \(U.S.\)](#)

English

[Instruction Sheet \(U.S.\)](#)

English

Agency Approvals

[CSA Certificate](#)

English